

Datasheet - AZ 415-11/11ZPK

Safety switch with separate actuator / AZ 415



Preferred typ



- Metal enclosure
- Long life
- High level of contact reliability with low voltages and currents
- Adjustable ball latch to 400 N
- 2 cable entries M 20 x 1.5
- Spring-loaded actuators
- 2 switches with different actuating functions in one enclosure
- 84,6 mm x 103,6 mm x 46,5 mm

(Minor differences between the printed image and the original product may exist!)

Ordering details

Product type description	AZ 415-11/11ZPK
Article number	101154000
EAN Code	4030661170701
eCI@ss	27-27-26-02

Approval

Approval



Classification

Standards	EN ISO 13849-1
B10d Normally-closed contact (NC)	2.000.000
B10d Normally open contact (NO)	1.000.000
- notice	at 10% Ie and ohmic load
Mission time	20 Years
notice	

$$MTTF_d = \frac{B_{rod}}{0,1 \times n_{op}}$$

$$n_{op} = \frac{d_{op} \times h_{op} \times 3600 \text{ s/h}}{t_{cycle}}$$

Global Properties

Permanent light	AZ 415
Standards	EN 60947-5-1, BG-GS-ET-15
Compliance with the Directives (Y/N) 	Yes
Number of guard doors	1
Materials	
- Material of the housings	Aluminium
- Material of the contacts	Silver
Housing coating	painted
Weight	495

Mechanical data

Design of electrical connection	Screw connection
Cable section	
- Min. Cable section	2 x 0,75
- Max. Cable section	2 x 1.5
Mechanical life	> 1.000.000 operations
notice	All indications about the cable section are including the conductor ferrules.
higher Latching force (Y/N)	Yes
Latching force	80 N ... 400 N
Positive break force	31
positive break travel	3.8
Max. Actuating speed	0,2 m/s

Ambient conditions

Ambient temperature	
- Min. environmental temperature	-25
- Max. environmental temperature	+70
Protection class	IP67 to IEC/EN 60529

Electrical data

Design of control element	Normally open contact (NO), Opener (NC)
Switching principle	Creep circuit element
Number of auxiliary contacts	3
Number of safety contacts	1
Rated impulse withstand voltage U_{imp}	4 kV
Rated insulation voltage U_i	250 V
Thermal test current I_{the}	6 A
Utilisation category	AC-15: 230 V / 4 A; DC-13: 24 V / 4 A
Max. fuse rating	6 A gG D-fuse To DIN EN 60269-1

ATEX

Explosion protection categories for gases	None
Explosion protected category for dusts	None

Dimensions

Dimensions of the sensor

- Width of sensor	84.6
- Height of sensor	103.6
- Length of sensor	46.5

Included in delivery

Actuators must be ordered separately.

Diagram

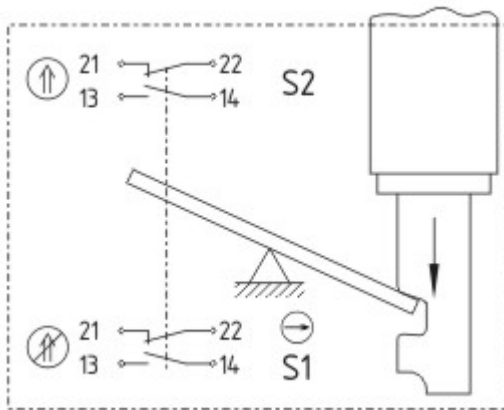

Note Diagram

- positive break NC contact
- active
- no active
- Normally-open contact
- Normally-closed contact

Switch travel diagram

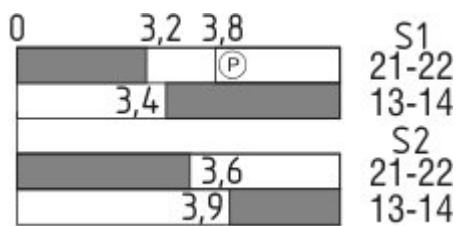

Notes Switch travel diagram

- Contact closed
- Contact open
- Setting range
- Break point
- Positive opening sequence/- angle
- VS** adjustable range of NO contact
- VÖ** adjustable range of NC contact
- N** after travel

Ordering suffix

The applicable ordering suffix is added at the end of the part number of the safety switch.

Order example: AZ 415-11/11ZPK-**1637**

...-**1637**

0,3 µm gold-plated contacts

Documents

Operating instructions and Declaration of conformity (es) 288 kB, 10.11.2017

Code: mrl_az415_es

Operating instructions and Declaration of conformity (nl) 289 kB, 23.11.2017

Code: mrl_az415_nl

Operating instructions and Declaration of conformity (en) 288 kB, 10.11.2017

Code: mrl_az415_en

Operating instructions and Declaration of conformity (de) 265 kB, 10.11.2017

Code: mrl_az415_de

Operating instructions and Declaration of conformity (jp) 382 kB, 29.11.2017

Code: mrl_az415_jp

Operating instructions and Declaration of conformity (fr) 289 kB, 10.11.2017

Code: mrl_az415_fr

BG-test certificate (de) 1 MB, 07.06.2017

Code: z_z41p01

BG-test certificate (en) 1 MB, 07.06.2017

Code: z_z41p02

CCC certification (cn) 3 MB, 18.10.2017

Code: q_175p03

CCC certification (en) 3 MB, 29.08.2017

Code: q_175p02

EAC certification (ru) 844 kB, 05.10.2015

Code: q_6037p17_ru

Images

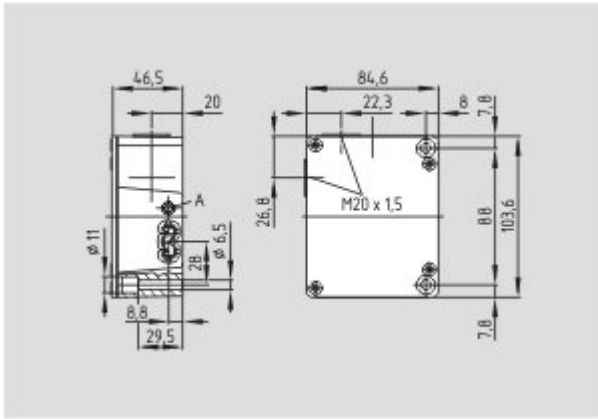

Dimensional drawing (basic component)

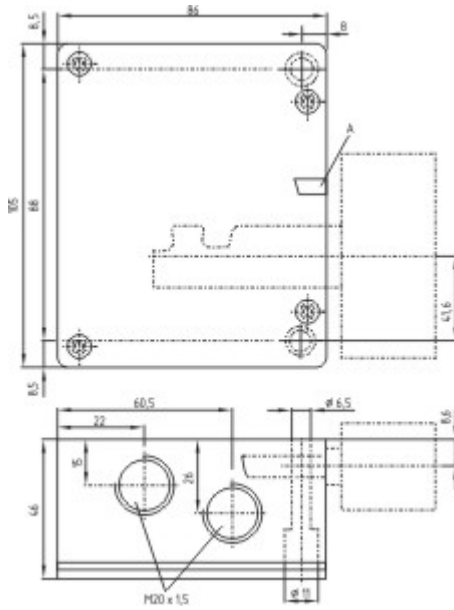

Dimensional drawing (basic component)

K.A. Schmersal GmbH & Co. KG, Möddinghofe 30, D-42279 Wuppertal

The data and values have been checked thoroughly. Technical modifications and errors excepted.

Generiert am 07.08.2019 - 10:19:49h Kasbase 3.3.0.F.64I