

## Datasheet - AZ 16-12ZI-B1

Safety switch with separate actuator / AZ 16ZI / AZ 16ZI-B1



Preferred typ



- Thermoplastic enclosure
- Individual coding
- Coding level "High" according to ISO 14119
- 52 mm x 90 mm x 30 mm
- Long life
- Double-insulated
- Large wiring compartment
- High level of contact reliability with low voltages and currents
- Insensitive to soiling
- Slotted holes for adjustment, circular holes for location
- 3 cable entries M 16 x 1.5

(Minor differences between the printed image and the original product may exist!)

### Ordering details

Product type description	AZ 16-12ZI-B1
Article number	101150050
EAN Code	4030661154442
eCI@ss	27-27-26-02

### Approval

Approval



### Classification

Standards	EN ISO 13849-1
B10d Normally-closed contact (NC)	2.000.000
B10d Normally open contact (NO)	1.000.000
- notice	at 10% I <sub>e</sub> and ohmic load
Mission time	20 Years
notice	

$$MTTF_d = \frac{B_{10d}}{0,1 \times n_{op}}$$

$$n_{op} = \frac{d_{ap} \times h_{op} \times 3600 \text{ s/h}}{t_{cycle}}$$

## Global Properties

---

Permanent light	AZ 16ZI
Standards	EN 60947-5-1, BG-GS-ET-15
Materials	
- Material of the housings	Plastic, glass-fibre reinforced thermoplastic, self-extinguishing
- Material of the actuator	Stainless steel
- Material of the contacts	Silver
Housing coating	None
Weight	156

## Mechanical data

---

Design of electrical connection	Screw connection
Cable section	
- Min. Cable section	0,75
- Max. Cable section	2.5
Design of actuators	straight, rigid
Mechanical life	> 1.000.000 operations
notice	All indications about the cable section are including the conductor ferrules.
With ejection force (Y/N)	Yes
Positive break force	20
positive break travel	8 mm
Actuating speed	max. 2 m/s
Minimum actuating radius	250 mm

## Ambient conditions

---

Ambient temperature	
- Min. environmental temperature	-30 °C
- Max. environmental temperature	+80 °C
Protection class	IP67 to IEC/EN 60529

## Electrical data

---

Design of control element	Normally open contact (NO), Opener (NC)
Switching principle	Creep circuit element
Number of auxiliary contacts	1
Number of safety contacts	2
Rated impulse withstand voltage $U_{imp}$	6 kV
Rated insulation voltage $U_i$	500 V
Thermal test current $I_{the}$	10 A
Utilisation category	AC-15: 230 V / 4 A, DC-13: 24 V / 4 A
Max. fuse rating	6 A gG D-fuse

## ATEX

---

Explosion protection categories for gases	None
Explosion protected category for dusts	None

## Dimensions

---

Dimensions of the sensor

- Width of sensor	52 mm
- Height of sensor	90
- Length of sensor	30 mm

## notice

Minimum actuating radius on hinged guards 250 mm

The axis of the hinge should be 5 mm above the top edge of the safety switch and in the same plane

The actuator is not available separately.

## Included in delivery

Individually coded actuator

tamperproof screws

Slot sealing plugs

## Diagram

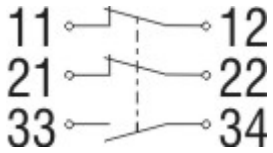



Note Diagram

 positive break NC contact

 active

 no active

 Normally-open contact

 Normally-closed contact

## Switch travel diagram

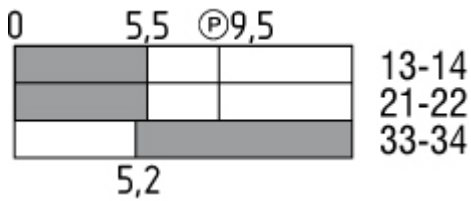



Notes Switch travel diagram

 Contact closed

 Contact open

 Setting range

 Break point

 Positive opening sequence/- angle

**VS** adjustable range of NO contact

**VÖ** adjustable range of NC contact

**N** after travel

## Ordering suffix

The applicable ordering suffix is added at the end of the part number of the safety switch.

Order example: AZ 16-12ZI-B1-1762



....-1762

Versions with M5 nuts  
For front mounting of safety switch, e.g. on sheet-steel covers  
Cannot be retrofitted

....-1637

0,3 µm gold-plated contacts

....-M20

cable entries M20

## Ordering code

---

AZ 16-(1)ZI-(2)-(3)

<b>(1)</b>	
<b>3.0</b>	3 Opener (NC)
<b>12</b>	1 Normally open contact (NO) / 2 Opener (NC)
<b>(2)</b>	<b>Actuator:</b>
<b>B1</b>	straight Design
<b>B1-1747</b>	straight Design with magnetic latch
<b>B1-2024</b>	straight Design with slot sealing plug
<b>B1-2053</b>	straight Design with ball latch
<b>B1-2177</b>	straight Design with centering guide
<b>(3)</b>	
<b>M16</b>	Cable entry M16
<b>M20</b>	Cable entry M20

## Documents

---

**Operating instructions and Declaration of conformity (jp)** 732 kB, 20.01.2017

Code: mrl\_az16zi\_jp

**Operating instructions and Declaration of conformity (nl)** 492 kB, 02.08.2018

Code: mrl\_az16zi\_nl

**Operating instructions and Declaration of conformity (it)** 465 kB, 21.11.2016

Code: mrl\_az16zi\_it

**Operating instructions and Declaration of conformity (pt)** 466 kB, 20.03.2019

Code: mrl\_az16zi\_pt

**Operating instructions and Declaration of conformity (da)** 361 kB, 25.01.2012

Code: mrl\_az16zi\_da

**Operating instructions and Declaration of conformity (en)** 517 kB, 28.09.2016

Code: mrl\_az16zi\_en

**Operating instructions and Declaration of conformity (de)** 515 kB, 28.09.2016

Code: mrl\_az16zi\_de

**Operating instructions and Declaration of conformity (ro)** 362 kB, 25.01.2012

Code: mrl\_az16zi\_ro

**Operating instructions and Declaration of conformity (fr)** 468 kB, 18.11.2016

Code: mrl\_az16zi\_fr

**Operating instructions and Declaration of conformity (es)** 471 kB, 21.11.2016

Code: mrl\_az16zi\_es

**Operating instructions and Declaration of conformity (cn)** 609 kB, 11.05.2017

Code: mrl\_az16zi\_cn

**Operating instructions and Declaration of conformity (sv)** 343 kB, 17.06.2015

Code: mrl\_az16zi\_sv

**Operating instructions and Declaration of conformity (pl)** 503 kB, 01.12.2016

Code: mrl\_az16zi\_pl

**BG-test certificate (en)** 536 kB, 05.01.2011

Code: z\_\_16p02

**BG-test certificate (de)** 203 kB, 02.03.2016

Code: z\_\_16p01

**CCC certification (cn)** 3 MB, 18.10.2017

Code: q\_175p03

**CCC certification (en)** 3 MB, 29.08.2017

Code: q\_175p02

## Images

---

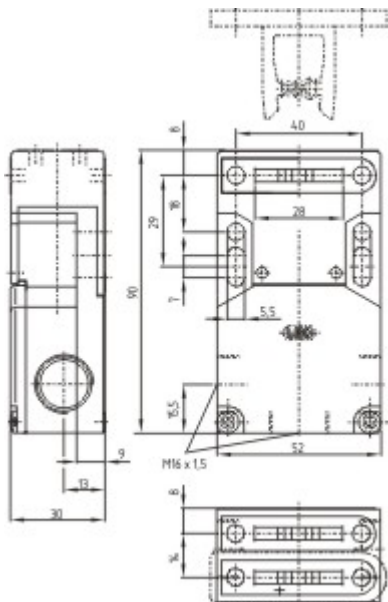

Dimensional drawing (basic component)

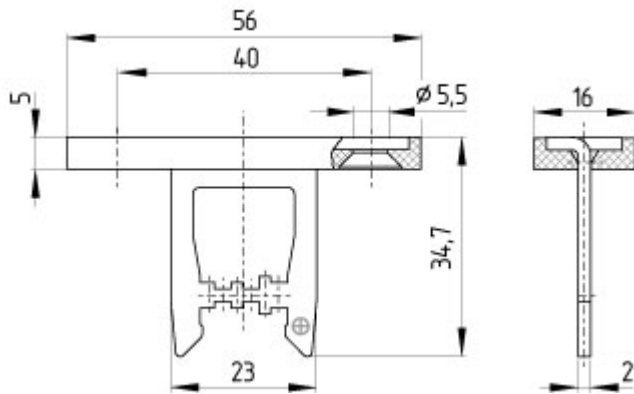

Dimensional drawing (miscellaneous)

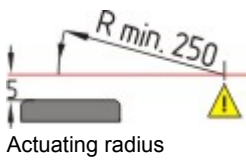

Actuating radius

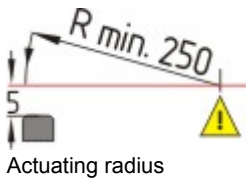

Actuating radius

## System components

### Mounting accessories



#### 1135338 - TAMPERPROOF SCREWS M 5 x 12

- To mount the actuator
- Higher protection against tampering with interlock
- Protects against unauthorised removal of actuator
- Various lengths available



#### 101135339 - TAMPERPROOF SCREWS M 5 x 16

- To mount the actuator
- Higher protection against tampering with interlock
- Protects against unauthorised removal of actuator
- Various lengths available



#### 101135340 - TAMPERPROOF SCREWS M 5 x 20

- To mount the actuator
- Higher protection against tampering with interlock
- Protects against unauthorised removal of actuator
- Various lengths available